

OPTONICA

User Manual

Android Touch Screen



Content

Assembly and Connection	3
E. g. Packing List for floor stand non touch screen	3
Steps for Assembly	4
Steps for Assembly with Casters	5
Power on/off	6
Getting Familiar with Android: Main Interface and Essential Settings	7
Two Methods to Publish Advertising Content:	8

Features

- ◎ 1 ◎ Embedded with Android 4.4/6/7.1/9.0/11.0/12.0/13.0/14.0 smart operating system and unique UI design, bringing you a more convenient operation and better visual experience.
- ◎ 2 ◎ Support USB mouse and keyboard, realizing easy manipulation like a computer. Using a mouse for set up is recommended.
- ◎ 3 ◎ Built-in Wi-Fi module, high capacity memory and high capacity cache, Making it smoother to playing 2K/4K photos and videos.
- ◎ 4 ◎ High-quality LCD screen as the display, no flicker, low radiation, greatly reducing eye fatigue, eye protection, high brightness, high contrast, and wide viewing angle; ultra-fast response time greatly reduces ghosting of fast moving images.
- ◎ 5 ◎ Progressive image processing and industry-leading motion compensation technology improve the flickering and blurring in the edges of motion picture.
- ◎ 6 ◎ Dynamic contrast technology can significantly improve the clarity and contrast of various screens.
- ◎ 7 ◎ Multi-channel USB interfaces, HDMI input/output port for optional, supporting connect external devices
- ◎ 8 ◎ Ultra-thin narrow bezel design

Safety Warnings and Precautions

Thank you for purchasing the high-performance multi-functional LED backlight Digital Signage. We have considered the factors to ensure personal safety in product design and have tested rigorously at the factory. However, improper installation and use may result in electric shock and fire. In order to safely use, maximize performance of the unit and extend the life of the product, please read and follow all instructions carefully before using the product. Keep the instructions for future reference.

Symbol Legends:

 Warning: May cause personal injury or death

 The operation is prohibited

 Caution: May cause damage or property loss

 The operation must be executed

If any of the following occurs:

- ◆ Power outage or unstable voltage.
- ◆ Abnormal sound or smell from the unit.
- ◆ AC power cord is damaged.
- ◆ Digital Interactive Table is damaged due to drop, knock or impact.
- ◆ Any liquid or foreign matters fall into the enclosure.

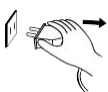

Turn off the Digital Advertising Player immediately, pull out the plug from the power outlet, and ask the authorized personnel for maintenance timely

 If coal gas or other flammable gas leaks, do not pull out the plug of the LCD Digital Signage or other electrical appliances; instead, turn off the gas valve immediately, and open the doors and windows quickly.



WARNING



- Do not use power supply other than 110V-240V 50/60Hz
- Cut off the power supply before connecting or disconnecting any cables.
- Do not place the Digital Signage on any unstable positions, or else it may be damaged or cause fire.
- Do not place the Digital Signage in the positions such as:
 1. The environment subject to direct strong sunlight, moisture, extreme temperature or too much dust;
 2. The environment with flammable or explosive materials;
 3. The environment with flammable or corrosive gases;
- Do not use damaged or inappropriate power outlets, and ensure that the plugs and outlets contact properly.
- Do not let dust or metal deposits adhere to the plugs and outlets.
- Do not damage the power cords:
 1. Do not modify the power cords;
 2. Do not place heavy objects on the power cords;
 3. Keep the power cords away from heat source;
 4. Do not pull the cord to remove the plug.
- Do not connect too many plugs to one outlet in parallel, or else it may cause fire due to excessive power consumption.
- Do not approach the Digital Signage with open flame (e.g. a lighted candle), or else it may cause electric shock or fire.
- Do not put water filled container on the Digital Signage to avoid electric shock and fire due to water drops or splashing.
- Do not put any sharp objects, metal or liquid into the vents or let them touch the signal terminals to avoid short circuit, product damage, and electric shock.
- The openings in the enclosure are designed for ventilation and cooling, to ensure long time reliable running of components inside the enclosure and prevent overheating. Do not block the openings when place the unit.



Do not touch the plugs with wet fingers, or else it will cause electric shock



Do not use the Digital Signage in stormy weather, especially when there is lightning; instead, please disconnect the power and antenna plugs to avoid lightning strike.



Do not disassemble the Digital Signage without permission, or else it may cause electric shock or fire. Please ask qualified technician for repair.













CAUTION



- Do not let children climb onto the Digital Signage.
- Keep the small parts away from children to prevent them from swallowing.
- If the Digital Signage won't be used for a long time, please turn it off and pull out the power plug.
- To adjust the position or angle of the Digital Signage, please disconnect all power cords and move slowly to avoid falling.
- Do not scratch or knock the LCD with hard object, or twist and squeeze the LCD.
- Do not turn on the unit immediately when it is moved from a place with low temperature to high temperature, or else it will
 - cause condensation and malfunction.
- Before cleaning the Digital Signage, please pull out the power plug; wipe with soft cloth; do not use industrial chemicals; prevent foreign matters from entering the machine. Improper cleaning (such as cleaning solution, water) may damage the product, erase the printed information, and even cause damage of the components if fluid flows in, resulting in machine failure.
- If the unit displays the same screen for a long time or the moving picture has fixed text or icon, it will leave ghosting on the screen and won't disappear when the unit is turned off, it is normal and isn't covered by the warranty.
- The power of the Digital Signage can be cut off by pulling out the plug.
- If the LCD screen ruptures and the liquid splashes on the skin, please rinse for 15 minutes with clean water immediately,
 - and consult your doctor.
- To carry the Digital Signage with hands, please grab the corners and hold the bottom; do not apply pressure on the panel.
- Use the Digital Signage properly: Use in proper lighting conditions, insufficient lighting or long time watching will impair your eyesight.
- When the plug is used as disconnection device, it should be easy to operate the device.
- Insert the plug into the outlet properly, or else it may cause sparks and fire.
- The technical specifications printed herein and on the packaging are subject to change without prior notice. The Manual may be slightly different from actual operation, and the latter is applicable.

Assembly and Connection

E.g. Packing List for floor stand non touch screen

Item	Name	Qty.	Item	Name	Qty.	Item	Name	Qty.
	Screen	1		Stand Base	1		Warranty Card	1
	Key	2		Set Screws	10		Casters (Optional)	4
	PowerCord	1		Quick Start Guide	1		Qualified Certificate	1
	Hex Wrench	1		WiFi antenna	1			

Please note: Accessories might vary slightly between production batches. Your actual product package contents may differ from what's shown in this manual.

Please note: The interfaces shown and installation steps provided are for reference only. Due to variations in production batches and product types, additional listings will not be provided. The actual product shall prevail.

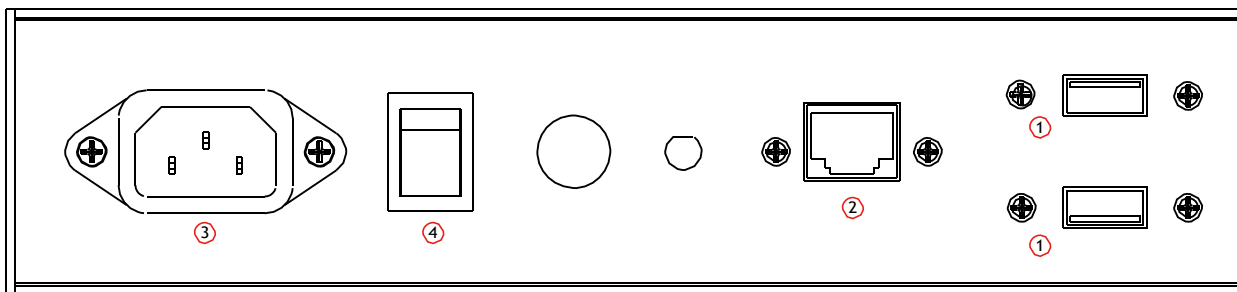

1.USB interface; 2.RJ45 interface(Ethernet); 3.Power port; 4.On/Off button;

Note: Please pull out the power plug before installing or disassembling the unit !

Steps for Assembly

1. Remove the screws with screwdriver and open the wood case;
2. Unlock the Toggle Latches and carefully take out the master carton from one side
3. Open the master carton and remove EPE on both sides of the box;
4. Take out the base from the package;
5. Carefully lift out the unit and place it on the solid flat surface (avoid scratching);
6. Assemble the base and the unit with dedicated screws using hex wrench

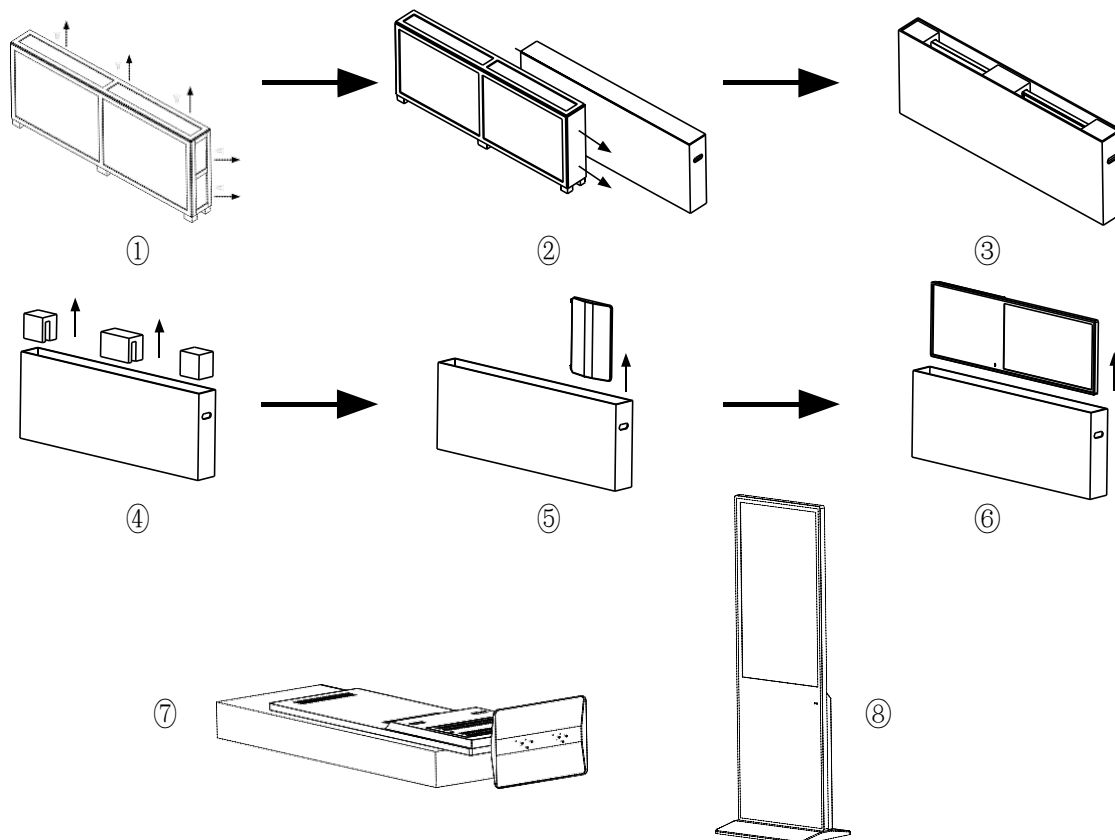

Steps for Assembly with Casters

1、 To use this product as a mobile unit, install 4 casters to the metal base by threading them into the holes on the bottom of the base. Tighten all casters with screwdriver.

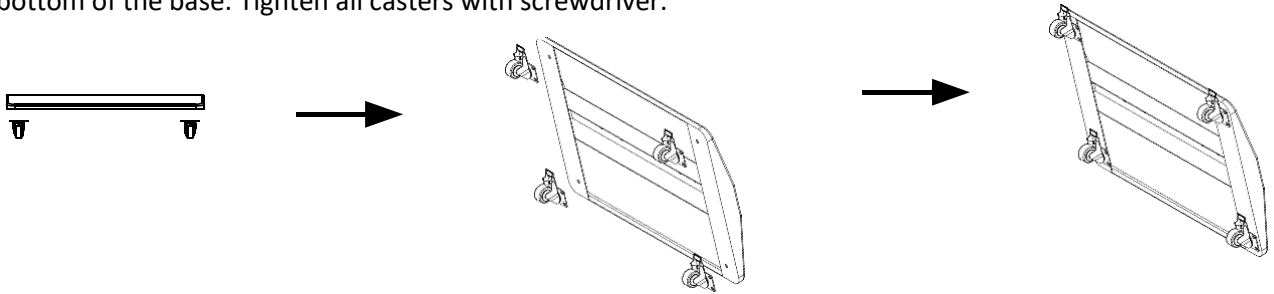

2、 Connect the base and the digital signage with provided screws. Tighten all screws with an hex wrench.

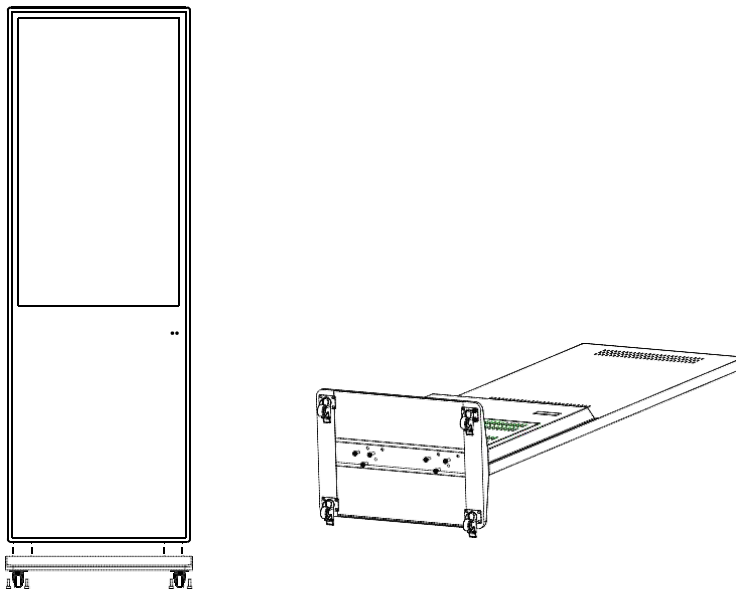

3、 The assembly is finished:



Description of Basic Operation

Power on/off

Insert the power plug into the outlet. If the Digital Signage has the switch button “ to “I” to turn it on; and press the switch button “O” to turn off the Digital Signage.

Note:

These two Android interface examples may differ slightly from your actual product. Different versions may have variations.

Getting Familiar with Android: Main Interface and Essential Settings

1. Home Page

For example: 3566 Android mother board

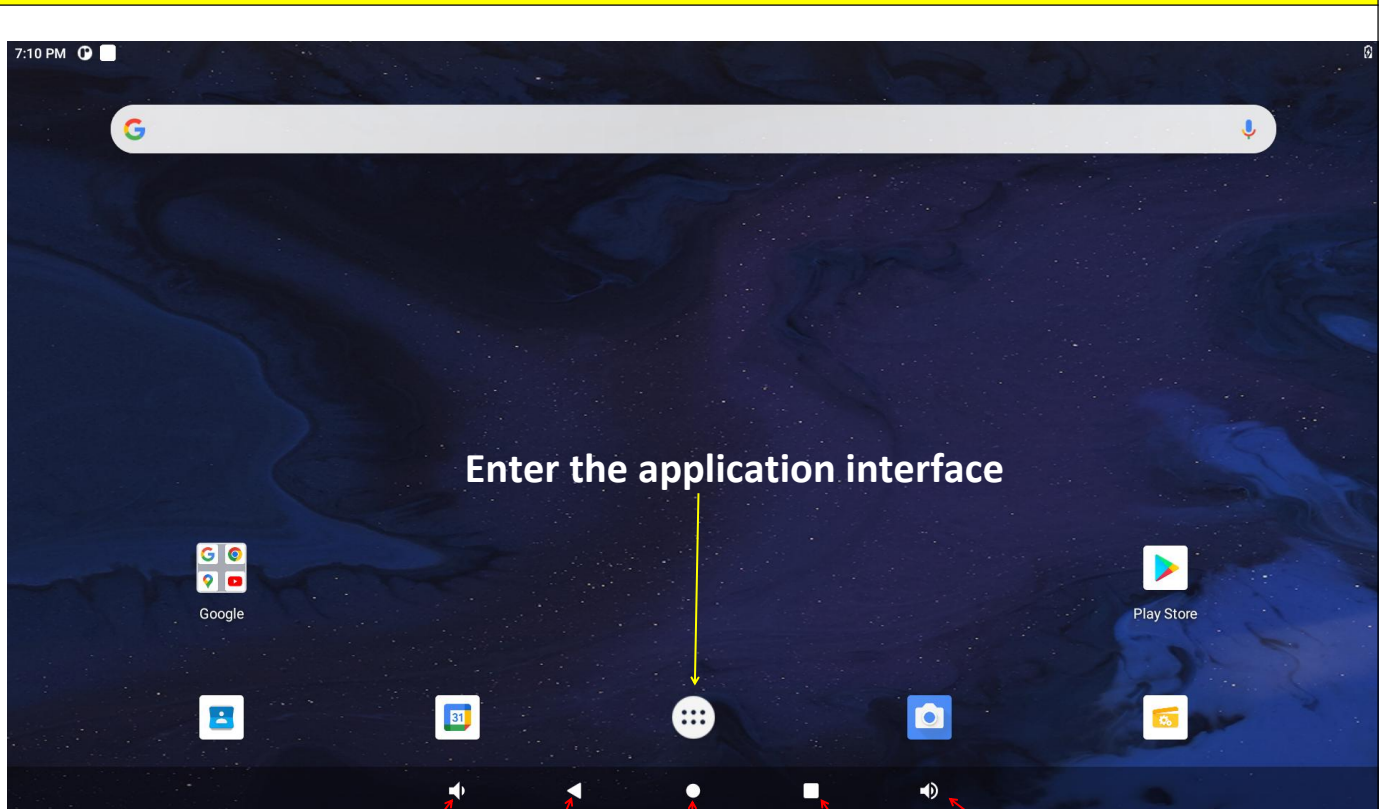

Volume -

Back

Home Page

Multi-app window

Volume +

2. Main Apps

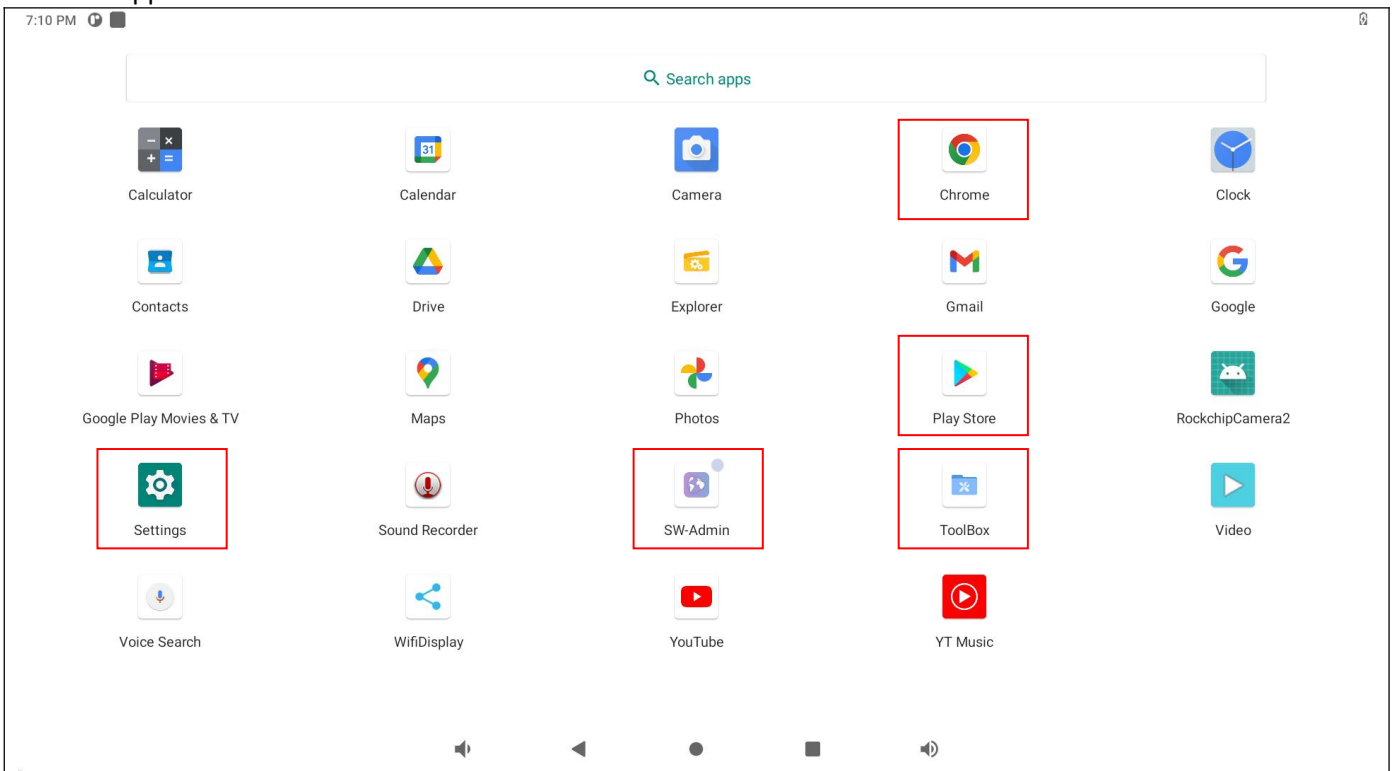

Main functions:

Chrome, File Manager[Explorer], Play Store, Settings, SW-Admin [BMES CMS for advertising], Toolbox, etc.

3. Settings

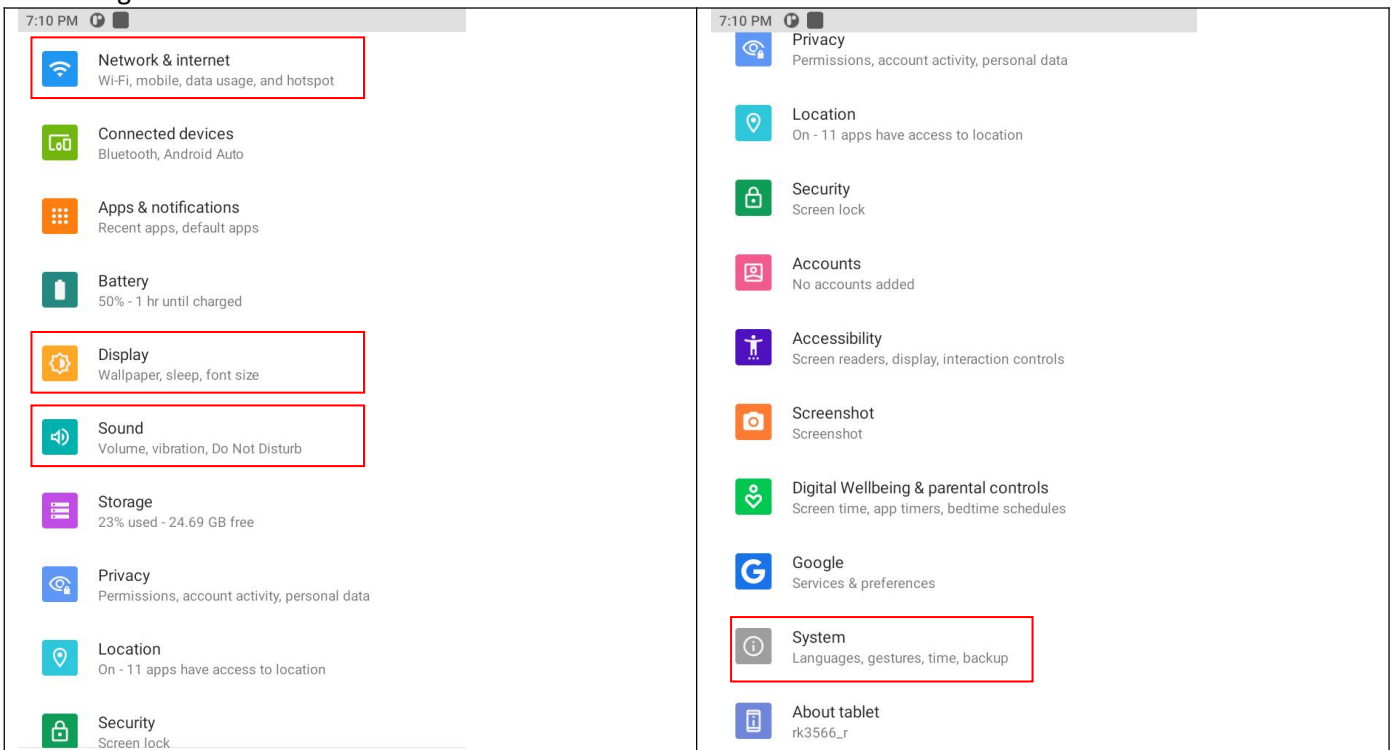

Main functions:

network[wifi], display, sound, etc.

Main functions:

Settings ---> System ---> Languages / time, etc.

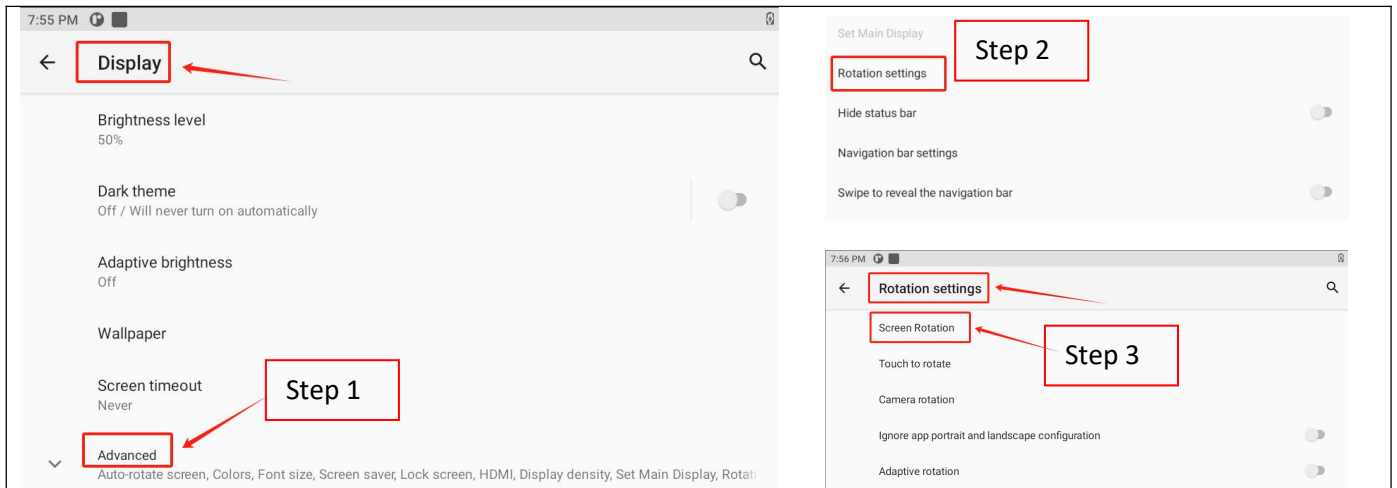

Settings ---> Display ---> Advanced ---> Rotation Settings ---> Screen Rotation

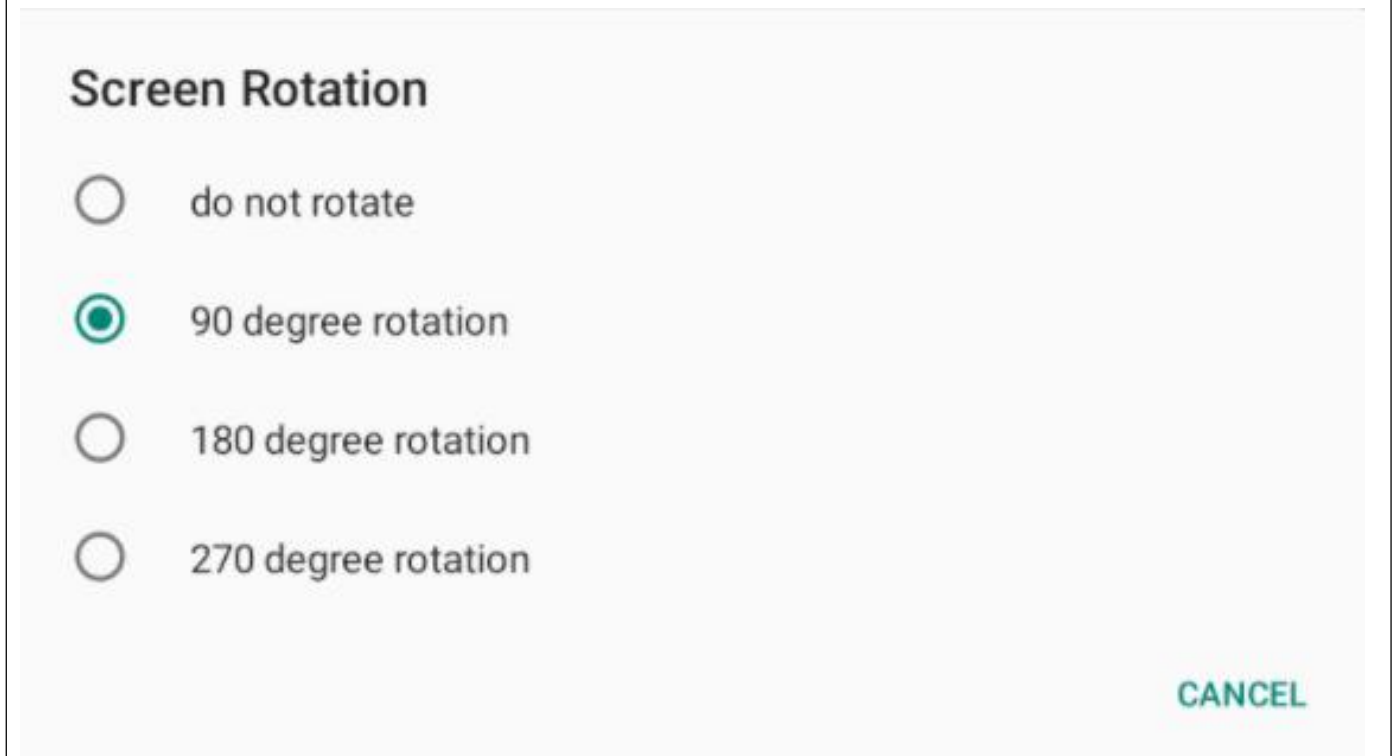

Two Methods to Publish Advertising Content:

USB Drive Method

Copy your advertisement images/videos to a USB drive. Under the Signworld display interface, insert the USB drive into the screen's USB port - the system will automatically load the content. After uploading completes, safely remove the USB drive. For detailed instructions, please refer to the Signworld User Manual & Video Guide.

Network Method

Access the Settings interface and configure WiFi connection to join a local network with strong signal, or alternatively connect via Ethernet cable to the RJ45 port. Once successfully connected to the network, follow the Signworld User Manual & Video Guide to remotely publish advertising content from your computer.