

1. Link Track & Driver by L/N poles
(reference below instruction)

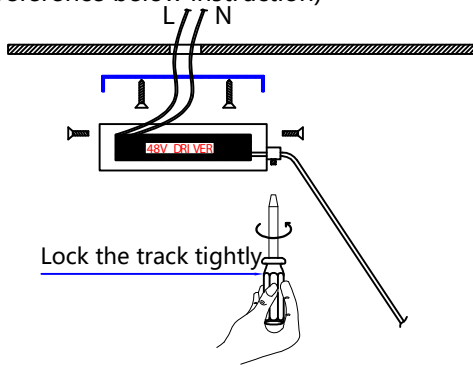

2. Reference below photos to assemble the track fixing parts.

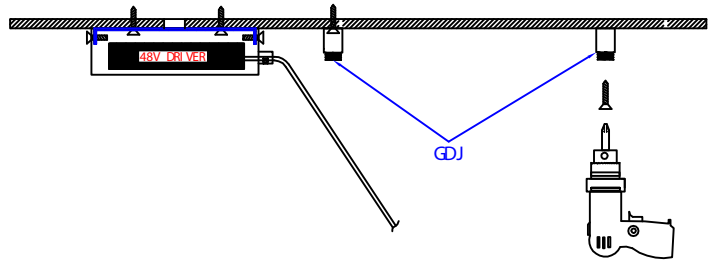

3. Assemble the track, Pull it in Straight in flattening.

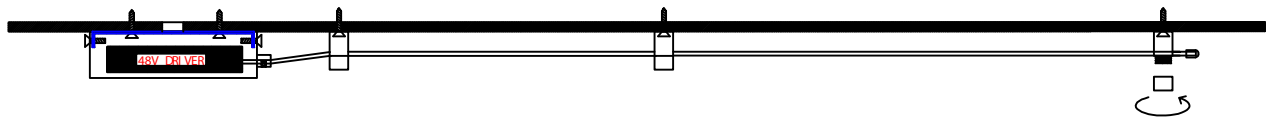

4. Assemble the Fixtures

Track fixing part assembled nearby spot light in 5-10cm.

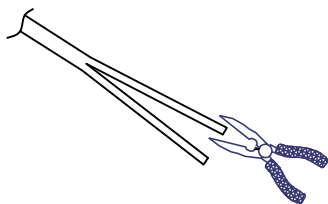
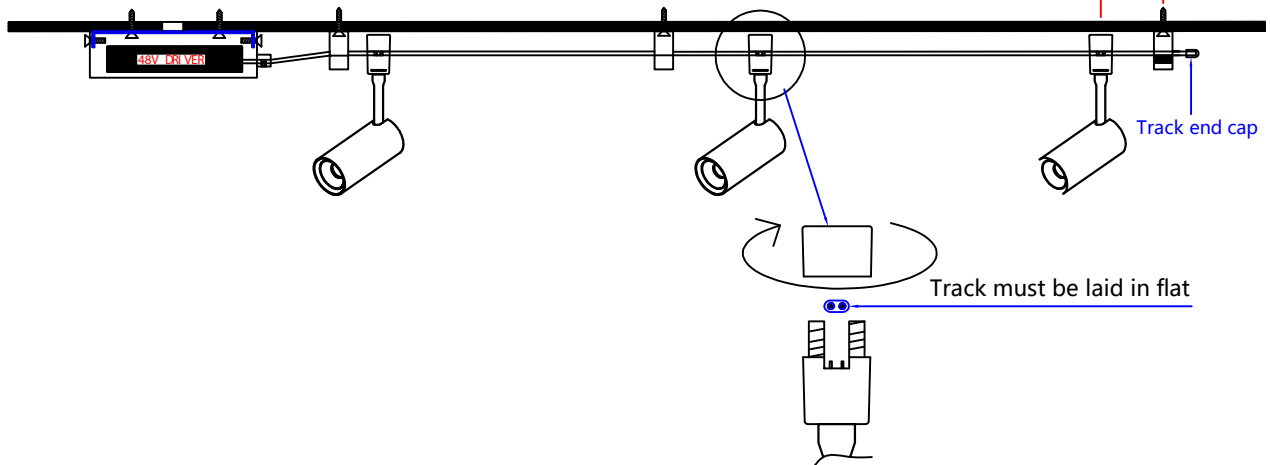

Cut the middle of the wire

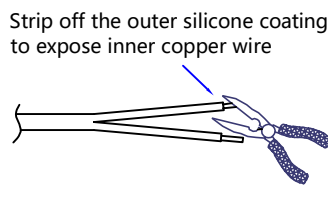

Strip off the outer silicone coating to expose inner copper wire

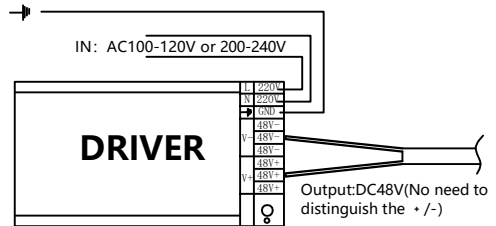

Connect two copper wires to the DC port of the power supply

Attention:

1. Loosen the cap of the fixing fixture, then adjust the flexible track.
2. Loosen connection cap of the lamp, then move it for adjustment.
3. The weight of all lamps between two fixing should $\leq 3\text{KG}$.
4. The total power of lamps shall not exceed 80% of driver's power. Please make sure driver output is same as fixture input (DC48V/ DC24V) before install the lamps.
5. Don't pull the flexible track after installation.
6. Note: Different spatial shapes are determined by the location of the fixed point, which should be installed according to the design drawing.
7. Due to voltage drop considerations, the track length from the driver to the terminal end to a maximum of 15 meters.