

Breathe Cleaner and Healthier Air

OPTONICA
Comfort

AIR PURIFIER

USER MANUAL



Thank you for purchasing.
 Please read this user manual carefully before you use the appliance.
 After reading this manual, keep it in a convenient location for further reference.

CONTENTS

Performance Indicators.....01
 Packing List.....02
 Purifier Features.....02
 Product overview.....04
 Circuit diagram.....04
 Install filter.....05
 Control overview.....06
 Function Descriptions.....08
 Installation Notice.....10
 Safety Precautions.....11
 Mandatory items.....13
 Cleaning and Maintenance.....14
 Replacing the filters.....16
 Troubleshooting.....17

Product Name	Air Purifier
Rated Voltage~Frequency	220V~50Hz
Power	80W
Noise (Low)	≤29.4dB
Ionizer	20million/cm ³
CADR(PM2.5)	320 m ³ /h
CCM(PM2.5)	P4
CADR (Formaldehyde)	80 m ³ /h
CCM (Formaldehyde)	F4
Application Area	22~38 m ²
Filter Replace Time	Filter #1 2 years, #2 & #3 6 months
Net Weight	8.0KG
Gross Weight	11.0KG
Product Size	370x195x650mm
Packing Size	433x256x720mm
Purification	Pre-filter, Cold-catalyst, Honeycomb activated carbon filter, Antibacterial filter, UV Sterilization, HEPA filter, Anion release.

Packing List

Machine	1 Piece
Remote Control	1 Piece
Filters	3 PCS
User Manual	1 Piece

Purifier Features

Aluminum Pre Filter

Aluminum Pre Filter, Remove Large Granule Dust, Dander, Pollen, Floating Compound And Other Pollutants. Washable And Reusable.

Cold Catalyst Filter

The Cold Catalyst Will Play a Catalyst Effect In Normal Living Environment Without Any External Assistance Like UV light, Sunlight, High Temperature Or Pressure.

The Cold Catalyst Can Be Used To Deal With Formaldehyde, Ammonia, Benzene, TVOC, Hydrogen Sulfide And Other Harmful Gases Released By Plywood, Furniture, Wallpapers, Carpets, Curtains And Bedspreads.

Honeycomb activated carbon filter

The honeycomb activated carbon carries high efficient additives. It has good absorption and dust collection characteristics.

Antibacterial Filter

The 5 Microns Filter with Antimicrobial Agents Can Efficiently Kill Bacteria In The Air.

High Efficiency HEPA Filter

The Precision Of The HEPA Filter Is 0.01 Micron, And It is Able To Eliminate Particles Which Are Larger Than 0.01 Micron With The Filtration Rate Of 99% Or More. Dust, Bacteria, Fungi, Viruses, Allergens And Other Small And Tiny Particles Are Not Able To Get Through The HEPA Filter.

UV Sterilize Light

A Variety Of Bacteria Can be Killed by the 365nm UV Light. The UV Germicidal Lamp is used to purify the air and it is able to eliminate odor caused by smoke and mold.

Anion Release

The Ionizer Release Large Amount Of Anions And Make the Oxygen Negatively-Charged, Thus Gathering The Positively-Charged Particles Like Floating Dust, Bacteria, Viruses And Smoke. The Particles Become Denser And Sink To the Ground. The Smaller The Particle Size, The Higher The Capture Rate.

Product overview

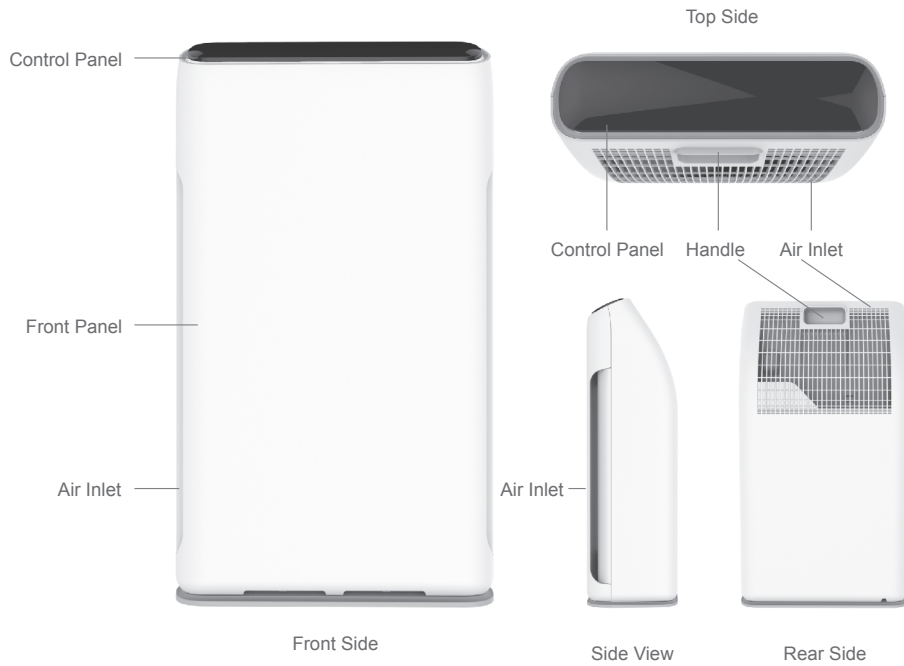

Circuit Diagram

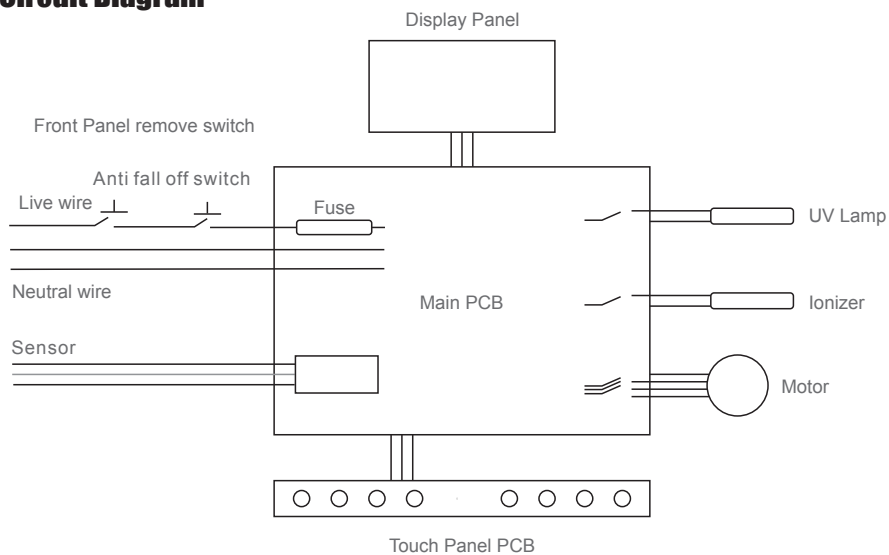

Install filter

1. Take Out filter from Machine

- Open the cover

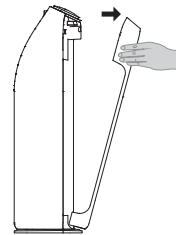
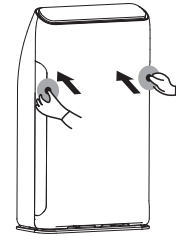

- Take out the filters

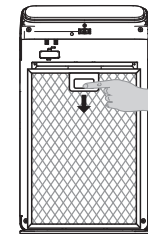

- Remove all packaging material

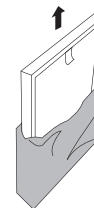

2. Install filter and Front panel

- Install filter 3 (Antibacterial + HEPA compound filters)
Note: Please ensure the tab side is facing you.

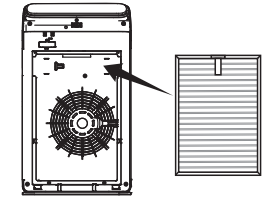

- Install filter 2 (Cold Catalyst + Activated carbon Filters)
Note: Please ensure the tab side is facing you.

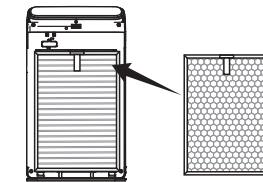

- Install filter 1 (Pre-filter)
Note: Please ensure the handle side is facing you.

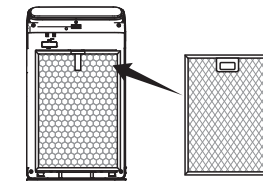

- Install front plate

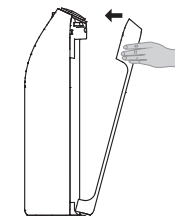



Control overview

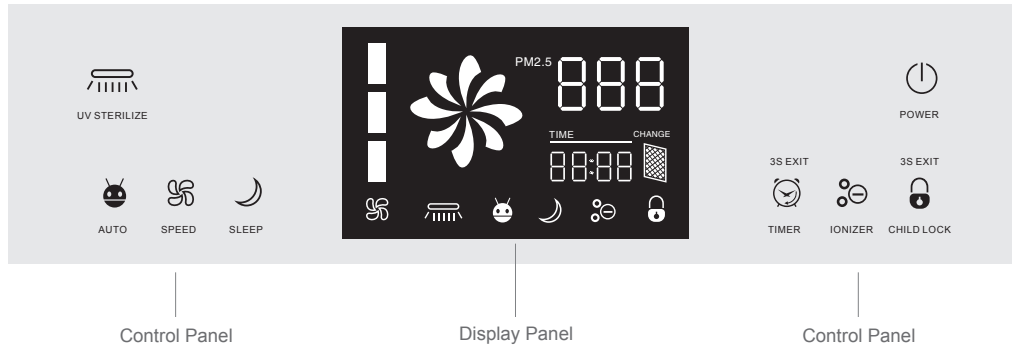

1. Switch on



Touch the power button at standby mode. Machine will on last time running mode. (Not including timer and sleep mode.)
 Machine will go into standby mode after press the power button when it on running mode. It will record the current operation mode at the same time.
 Remark: The machine include panel switch and anti fall switch. Machine won't turn on when remove panel and machine fall down.

2. Select the operating mode



All button will disable when press child lock. Icon will light up and keep running. Press this button for 3 seconds to exit this mode.



Ionizer will on/off when press this button. The icon will light up and down accordingly. Motor will turn on and stay low speed mode if you press this button at standby mode.

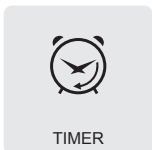

Press this button to set the working time. Every time increase 30 minutes. It will recycle after 12 hours. You can press 3 seconds to exit this mode. The machine will go into standby mode and exit timer mode if you press this button but machine not at purifying mode. (Display panel will show 00:30 1:00 1:30 2:00 2:30.....)



UV sterilize on/off after press this button when machine running. Icon will light up or down at the same time. Motor will turn on and stay low speed mode if you press this button at standby mode.



Press auto button on the control panel, machine into auto mode, "Auto" indicator on the panel. Under this mode, according to the degree of air pollution, automatic to start work, air volume automatically adjust. PM2.5<60 (Low speed), 60≤PM2.5<150 (Medium speed), PM2.5≥150 (High speed)

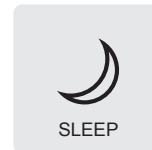

The display panel and light will turn off when sleep mode start. Motor only work at low speed. Timer is available at this mode. Machine will at standby mode after the time setting finish. Press any button to exit sleep mode.

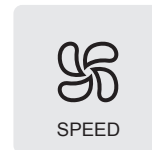

Press this button can adjust the motor speed at Low(500RPM), Medium(700RPM), High (900 RPM) and let the machine exit auto mode. The motor speed won't control by sensor if it's modify without permission.



Press child lock for 5 seconds when at normal working mode(child lock mode not start), it will show accumulated working time of the filter. It will disappear after 3 seconds.

3. Power Off

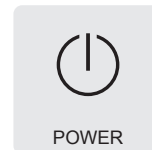

When machine running, it will turn into standby mode when press this button.

Function Descriptions

1. Remote Control

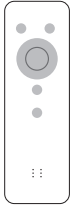

The product is equipped with remote control, use the button cell (If don't use the remote control for a long time, please take out the battery)

Note: The buttons on the remote control, the corresponding buttons on the operation panel, function and operation method are exactly the same, otherwise no introduction.

2. Product use

- Intelligent operation, the machine under the status of the power supply is connected, press the power button, and the smart key, the machine can run under the sensor intelligent induction. The operation of the motor gear will follow sensors adjusted value. This operation can use the vast majority of applications.
- Enforce running, the machine under the status of the power supply is connected, press the power button, key selection according to wind speed motor gear, to select on or off negative ions and UV germicidal lamp. Complete the purification function, suitable for the operating manual intervention force purification applications. In this mode cannot be automatically shift machine.
- The above two kinds of operating modes when it runs at night, as long as the sleep button is automatically in the purification of a machine, to ensure that no noise, will not effect your rest.
- Regular operation, the above three kinds of operation mode, simply press time, the setting of the machine running time, it will run the countdown, will stop running automatically after the times out. (If needs to cancel the timing, long press time 3 seconds to cancel this function.)
- Childlock mode, as long as you press the Childlock button, the control panel and buttons on the remote control can not work. (Long press 3 seconds locked to lift, or press the unlock button on the remote control)

3. Time setting

- Setting method, long press the smart key for 5 seconds, time display: Hour" digits flashing, press the speed key to add 1, press the sleep button to subtract 1, set "Hour" and then click the smart key again, "Minutes" digits in flashing, press the speed button to add 1, press sleep mode to subtract 1. (Press smart key back and forth for hours and wind speed. Press the wind speed and the sleep button to add or subtract set.)

Note:

- The clock function of this machine is completely independent, time display function accuracy or not does not affect the purification.
- The battery powered by the circuit board of the machine, it will consumption in the case of the machine is not plugged in. The battery is designed for the latest 10 days standby, it runs out of battery for more than 10 days, the clock function automatically reset. We need to set the clock again. (Refer to the back of the clock setting process)

Clock Setting Flowchart

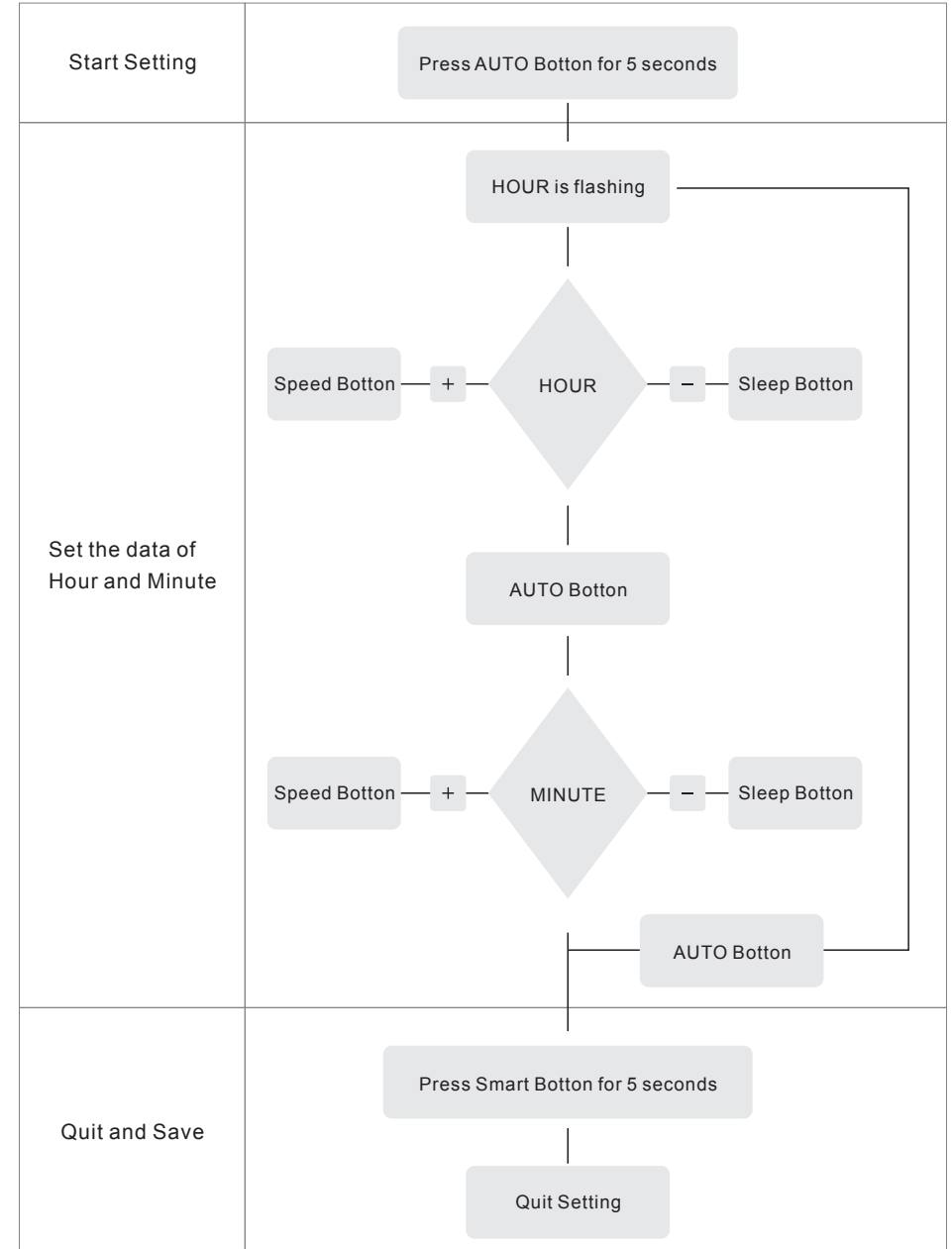

When Setting is done, SECOND setting is 00, and the clock move from current hour.

Installation Notice

1. Do not place on the following places

- Direct sunlight or facing outlet of air condition, Heated place. (May cause deformation, deterioration, discoloration and malfunction.)

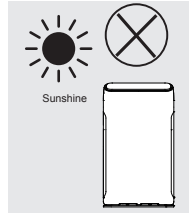

- Televisions and radios and other equipment nearby. (Images may cause disorder and noise, remote control machine, disruption to television and radio, please put more than 1meter away.)

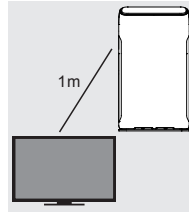

2. In view of the pollen and other indoor dust, this product should be placed on the ground.

- Pollen, dust and other easily fall near the floor, it is recommended that the product be placed on a flat ground in the room.

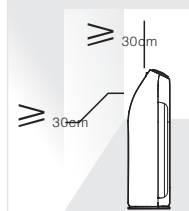

3. In order to make effective air circulation in the room.

- There should be a gap of at least 20cm at both sides and back of the product, while 30cm from the top surface.

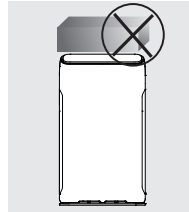

4. Do not place anything on the product .

(Otherwise may cause malfunction)

- Special Notice: Do not place magnets and metal object.

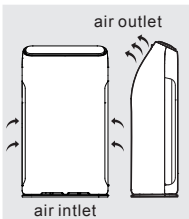

5. Do not block the air inlet and outlet.

- For example, do not place anything on the outlet or front air inlet.

Safety Precautions

1. Do not lift or move the machine when it working

Never pull the cord when moving or storing, may cause a short circuit or the power cord damage, fire or get an electric shock accident.

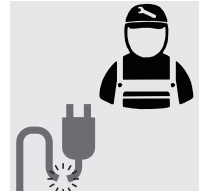

- ### 2. Do not damage the power cord or plug, do not cutting, excessive twisting, pulling, reverse power line. If the power cord is damaged, to avoid the danger, must be replaced by the manufacturer, the maintenance department or professional staff.

- ### 3. Do not use beyond the rated power, universal socket or connected devices, May cause the cord to overheat and cause fire accidents.

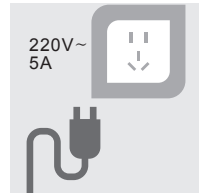

- ### 4. Do not touch the power plug with wet hands, may cause electric shock.

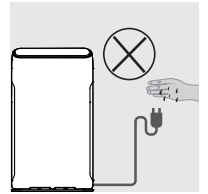

- ### 5. Prohibit the use of fingers or metal objects into the air outlet gap, may cause electric shock or injury.

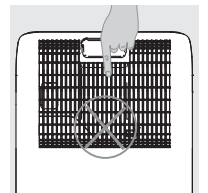

- ### 6. Do not let water, flammable detergent or other liquid into the product ,may cause electric shock or fire.

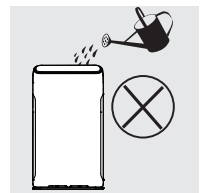

7. This product is not supposed to be used as daily ventilator , dust cleaner or cooker hood.

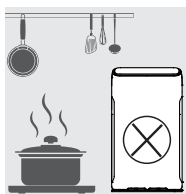

8. Do not use this product near as gas appliances, heating devices no near stove.

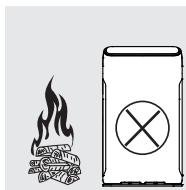

9. Do not use this product in a humid or high-temperature environment (e.g.bathroom, toilet or kitchen)



10. Do not allow children to have access to the remote control.



11. Do not place in such a place

- Unstable places(Products may drop, overturned, resulting in injury, cause leakage1, electric shock or fire accident)
- High temperature, high humidity or place of wet machine, e.g. the bathroom.
- Kitchen and other places of soot emission

12. Do not use air purifier in Aromatherapy scent insecticide environment

- Chemical residues may accumulate in the machine, then released from the outlet and harm to health
- After using insecticide, should thoroughly ventilate the room before using air purifier.

1. When the following occurs, please immediately turn off the power of the machine. (May cause electric shock, sparks, or smoke)

- Abnormal sound or vibration during operation
- Product odor, burnt smell

2. Please regularly clean the power plug

- Pullout the power plug, wipe with a dry cloth
- If do not use electrical appliances for a long time,please pull out the power plug

3. Before maintenance, make sure to disconnect the power

- Products may suddenly start ,causing electric shock and injury

4. Please safely insert the plug into the socket

- Do not use damaged plug or loose power socket

5. Please hold the plug insulation parts to pull out power plug

- Use the power cord to pull off the plug from the power cord, may cause power cord damaged, electric shock, short circuit, fire disaster

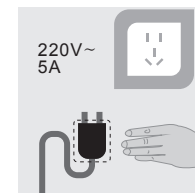

6. When any of the following occurs, please immediately turn off the machine and find the maintenance department

- A switch does not work
- The power cord or plug abnormal heat
- Abnormal sound or vibration
- Any anomalies or malfunctions

7.Unprofessional people is not allowed to install or uninstall the machine.

Cleaning and Maintenance

1. Pre-Filter(Every 15 days)

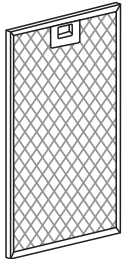

- Please use the vacuum cleaner to clean the dust on the surface of the screen, or wash with water, dry thoroughly.

2. Cold-catalyst filter / Honeycomb activated carbon filter (Every 2 months)

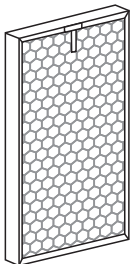

- Use the vacuum cleaner to clear the dust on the surface of the screen.
- Place the filter into the ventilated place. Don't expose under the strong sunshine.
- Do not force or hold on the filter.
- Do not use water to clean the filter.

3. Antibacterial / HEPA filter(Every 2 months)

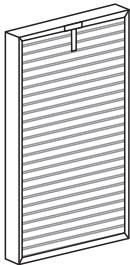

- Place the filter into the ventilated place. Do not expose under the strong sunshine.
- Do not use water to clean the filter.

4. Negative Ion Generator

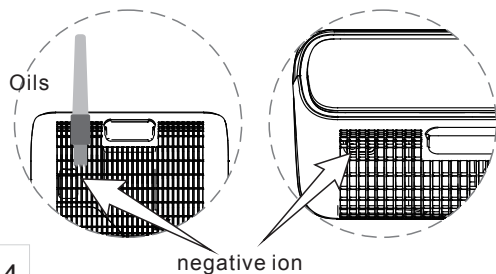

- When you hear the machine with a creak sound, use the brush pen as cleaning tool, regularly clean the dust around the negative ion.

5. Particle Sensor (Every 2 months)

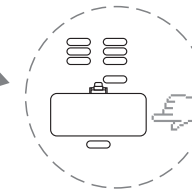
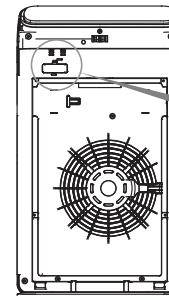

fig 1

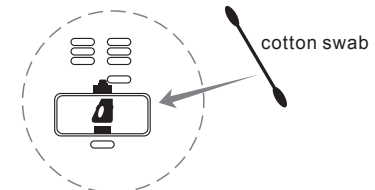
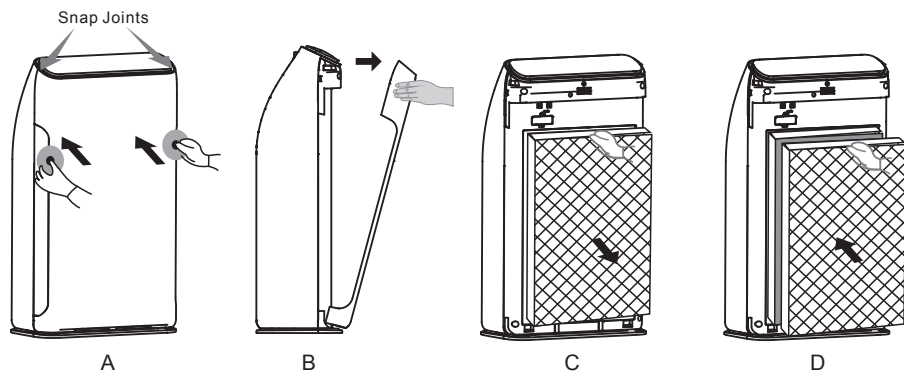

fig 2

- With a dry cotton swab and regular cleaning the lens to remove the moisture and smoke, remove the outer cover of particle sensor(fig 1), use the dry cotton swab to clean the lens (fig 2).
- Please ensure to disconnect the power before cleaning.
- Irradiated with light when it can't see clearly.

Tips

- Ensure to disconnect the power before cleaning and maintenance
- Do not open the machine when it removes the filter
- Please unplug power if the machine is not in use in long time
- According to the use of places and methods (e.g. The family with many of smokers or the place with serious pollution), the filter life will be shortened. Please replace the filter in time.



- A. Press the middle of front panel, to make the upper button out of its position.
- B. Pull out the front panel
- C. Take out the filters one by one
- D. Fill in new filters one by one in a correct consequence

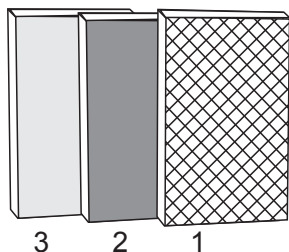

- 1. Pre-Filter
- 2. Honeycomb activated carbon filter / Cold Catalyst Filter
- 3. Antibacterial / HEPA Filter

- Suggest to maintain No.1 filter in every 15 days
- Suggest to maintain No.2 and No.3 filters in every 60 days
- Suggest to replace No.1 filter in every 2 years
- Suggest to replace No.2 & No.3 filter in every 6 months

Filter change reminding reset

The machine has filter change reminding function. It's set at 1500 hours. Please replace No.2 and No. 3 filter when "change" icon light up. Also please press the child lock button for 5 seconds to reset this function.

Usually problem and way of control and protect

Problem	Solution
Can not turn on or key has no response	<ol style="list-style-type: none"> 1. The power cord is plugged in? --Plug in the power. 2. The machine front plate is covered? --Cover the front plate 3. The machine is in the Child-lock mode? --When the display showed "child-lock" lights up, press the "child-lock/ reset" 5 seconds until the light off. 4. The machine is put on the flat place? --Put it on a flat place.
The air is dirty, but the indicator still show green color, even continuous operation, the indicator is always displayed in red.	<ol style="list-style-type: none"> 1. If the machine is put in the place of not easy to adsorbed the dirty air? --Change the place. 2. Particle sensor is dirty? --Clean the sensor.
Sound during operation	The negative ion generator is too much dust? --Clean the negative ion generator.
The smell of the outlet to let a person feel uncomfortable.	<ol style="list-style-type: none"> 1. Filter is dirty? --Clean the filter . 2. Filter for a long time did not change? --replace a new one.
Not into sleep mode automatically in the night.	Purifier in manual mode? --Press "Auto" button on the control panel, make sure enter the Auto mode.
Purifier work time is long , but the air purifier quality not improved obviously.	<ol style="list-style-type: none"> 1. Have remove the filter bag ? --Please remove filter bag in use of the first time. 2. Installation order filter is wrong? --Installation sequence .
Display is showed "F1" or "F2"	Please turn off the power immediately and find maintenance department.