

LED RGB/RGBW Controller 4CH 4*5A V4 Constant Voltage



Power



Light color

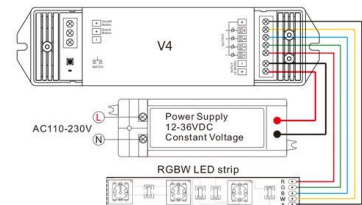
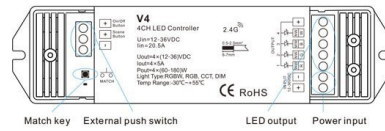
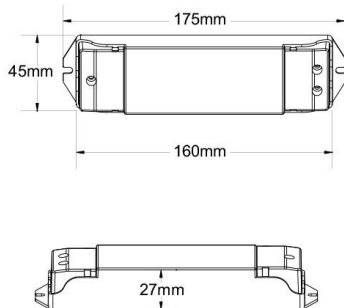

Technical specifications

Catalog number	6342
Body Color	White
Brand	Optonica
Product Code	AC2-A3
EAN Code	3800156663428
Input voltage	12-36VDC

IP	20
Items per box	100
Items per pack	1
Material	Plastic+Aluminium
Operating Frequency	50-60Hz
Output Power	4 x (60-180)W
Output Type	Constant Voltage
Size of Box	530x275x145 mm
Size of package	180x50x35 mm
Size of product	175x45x27 mm
Temperature	-30°C / +50°C
Warranty	2 Years
Weight of Product	150 gr.
Zones	4