

LED Flex-Neon 220V



Power

8.5W/m

Light color



Red

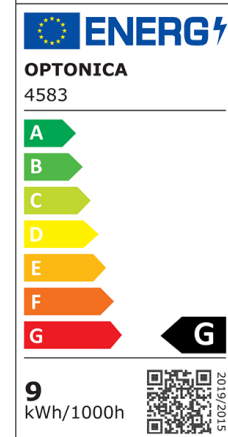
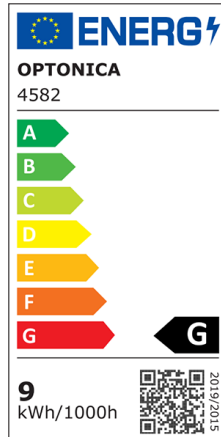
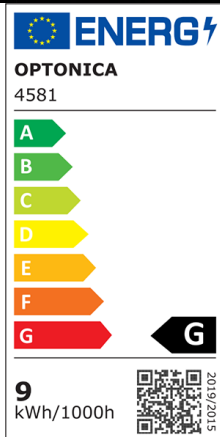
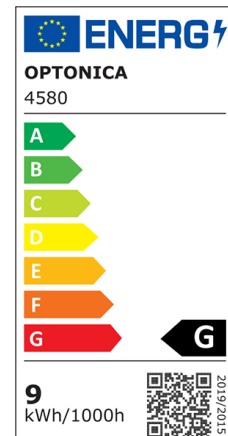
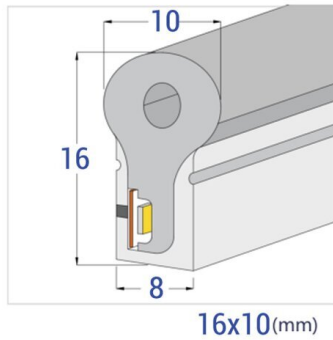

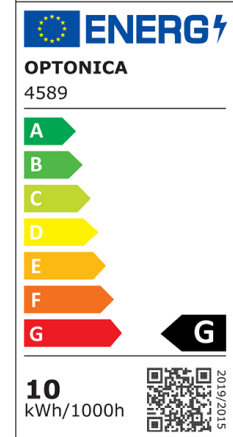
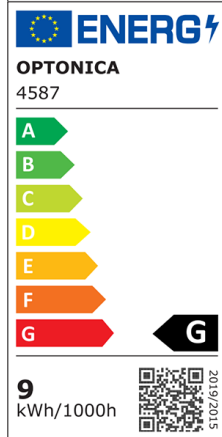
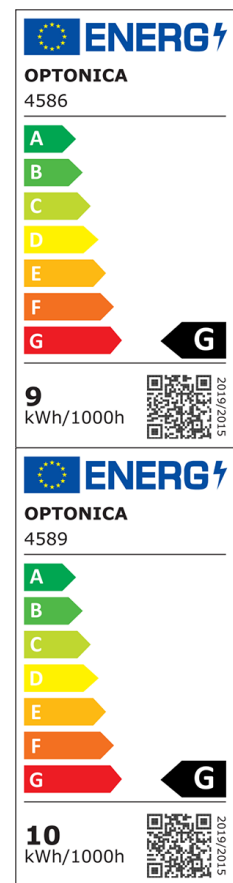
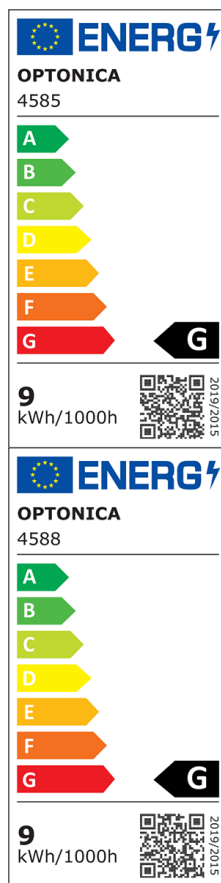

Technical specifications

Catalog number	4584
Beam angle	120°
Brand	Optonica
Product Code	ST220-A2
Color Designation	Red
Dimension	16x10 mm
Dimmable	Yes
EAN Code	3800156645844
Energy Efficiency Label	G
Input voltage	AC: 220V
Instant On	0.2s
IP	65
Flux	300 lm/m
LEDs/m	120
LED Type	SMD

Life span	25 000 Hours
Lumen maintenance at end of service life	70%
Material	Flex PCB
On/Off Cycles	25 000x
Operating Frequency	50-60Hz
Power per meter	8.5W/m
Power Factor	0.5
Roll	50 m.
Size of package	330x320x180 mm
Temperature	-30°C / +50°C
Warranty	2 Years
Weight of Product	10.750 kg./roll