

LED Flex-Neon 220V



Power

8W

Light color



Yellow

CE

RoHS

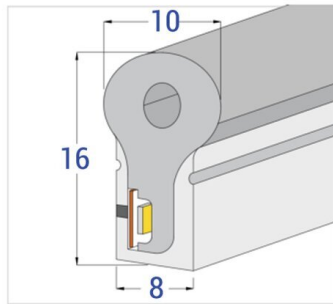

16x10(mm)

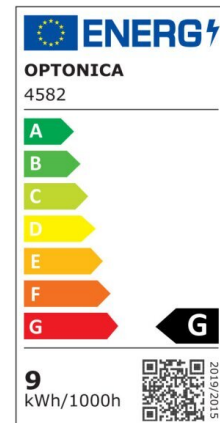
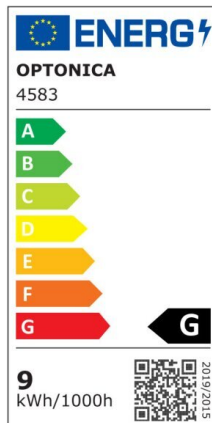
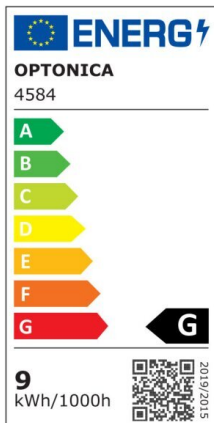
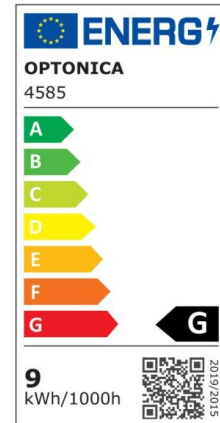

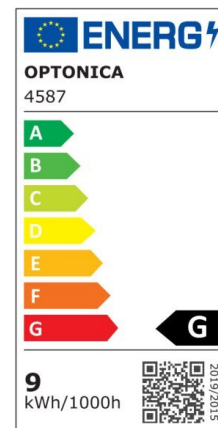
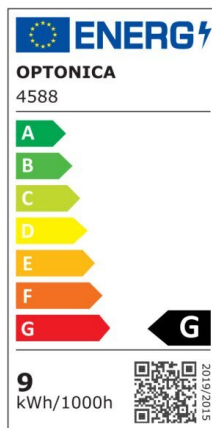
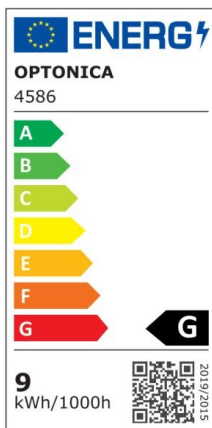
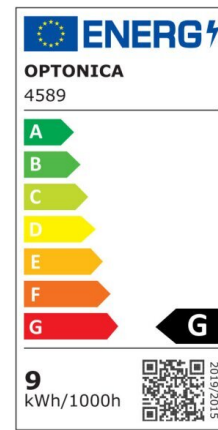
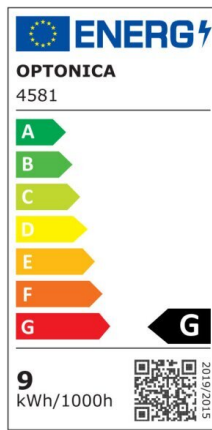
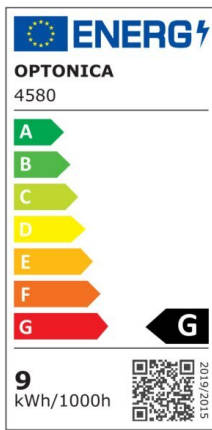

Technical specifications

Catalog number	4587
Beam angle	120°
Brand	Optonica
Product Code	ST220-A2
Color Designation	Yellow
Dimension	16x10 mm
Dimmable	Yes
EAN Code	3800156645875
Energy Efficiency Label	G
Input voltage	AC: 220V
Instant On	0.2s
IP	65
Flux	300 lm/m
LEDs/m	120
LED Type	SMD

Life span	25 000 Hours
Lumen maintenance at end of service life	70%
Material	Flex PCB
Mercury Free	Yes
On/Off Cycles	100 000x
Operating Frequency	50-60Hz
Power per meter	8W/m
Power Factor	0.5
Roll	50 m.
Size of package	330x320x180 mm
Temperature	-30°C / +50°C
Warranty	2 Years
Weight of Product	10.750 kg./roll